

Knoll

Tone Electric & Extended Electric— Stroke 665/420

User Manual



Knoll, Inc.
Customer Service
1235 Water Street
East Greenville, PA 18041

Contents

1	Important Information. SAFETY FIRST!	3
1.1	Important safety instructions. Please save these instruction.	4
1.2	User Information	6
1.3	Before you start:	6
1.4	Electrical rating	6
2	Assembly & Adjustment	7
2.1	Assembly Instruction	7
2.2	Setup procedure	7
2.3	Optional mounting guidelines	8
2.4	System configuration (example)	8
2.5	Adjustments	9
3	Operation Instructions	10
3.1	Basic functions	10
3.1.1	Upward desktop movement	10
3.1.2	Downward desktop movement	10
3.2	Advanced functions, Manual reset/homing	10
3.3	CDS (Collision Detecting System)	10
4	Maintenance & Repairs	11
4.1	Cleaning, Inspection and Storage	11
4.2	User Maintenance	11
4.3	Repairs	11
4.4	Servicing of double-insulated products	12
5	Appendix	13
5.1	Dimensions column system: Tone Extended Electric with 665 stroke	13
5.2	Dimensions column system: Tone Electric with 420 stroke	14
5.3	Accessories, Tone Electric & Extended Electric	15

1. Important Information—Safety First!

Your safety and the safety of others are very important. Please familiarize yourself with all instructions and safety warnings before operating the table. Please keep this manual for future reference.

To help you make informed decisions about safety, we have provided operating procedures and other information on labels and in this user's manual. This information alerts you to potential hazards that could hurt you or others. It is not practical or possible to warn you about all the hazards associated with operating or maintaining a table. Please use your own good judgment.

You will find important safety information in a variety of forms.

Safety Messages are preceded by a safety alert symbol  and one of three signal words: **DANGER**, **WARNING** or **CAUTION**. These safety messages are listed in order of severity, identify the general risks and what actions you are to take to avoid the risks. These signal words mean:

DANGER

Indicates an imminent hazard with a high risk of serious injury or death.

WARNING

Indicates a potential hazard that could result in serious injury.

CAUTION

Indicates a potentially hazardous situation, which could result in minor or moderate injury. It may also be used to alert against unsafe practices.

NOTICE

Indicates an alert to call attention to proper assembly instructions or particular operation procedures to assure correct equipment function and to avoid equipment damage or wear.

The information and specifications included in this manual were in effect at the time of approval for printing. Knoll reserves the right to discontinue or change specifications or design at anytime without notice and without incurring any obligation whatsoever.

1.1 Important safety instructions. Please save these instructions.

Please save these instructions.

When using an electrical table, basic precautions should always be followed, including the following:

Read all instructions before using table.

DANGER—To reduce the risk of electric shock:

1. Always unplug this furnishing from the electrical outlet before cleaning or servicing.

WARNING —To reduce the risk of burns, fire, electric shock, or injury to persons:

1. Unplug from outlet before putting on or taking off parts.
2. Unplug from outlet before putting on or taking off parts.
3. This table is not intended for use by children or individuals with a physical or other impairment, which may affect the ability to safely operate equipment.
4. Use this table only for its intended use as described in these instructions. Do not use attachments not recommended by the manufacturer.
5. Never operate this table if it has a damaged cord or plug, if it is not working properly, if it has been dropped or damaged, or exposed to water. In such event please return the table to a service center for examination and repair.
6. Keep the cord away from heated surfaces.
7. Never operate the table with the air openings blocked. Keep the air openings free of lint, hair, and the like.
8. Never drop or insert any object into any opening.
9. Do not use outdoors.
10. Do not operate the table in a potentially explosive atmosphere.
11. To disconnect, turn all controls to the off position, then remove plug from outlet.

WARNING—Risk of electric shock, fire and injury

Review the assembly instructions to confirm that the appropriate critical components and accessories are being used with the furnishings.

1. Connect this table to a proper outlet only. For loading always put heavier items at the bottom and not near the top in order to help prevent the possibility of the furnishing tipping over.

WARNING—Risk of injury to persons

1. Do not use this table to lift people and do not use this table to lift heavy parts or use this table as a platform for storage.
2. Maximum intended load is 265 pounds, uniformly distributed (120 kilograms) including the tabletop.

DANGER—Risk of electric shock, injury, or death

1. Improper usage, abuse, or misuse of the power supply, handset, motors and other electrical components may result in an electrical shock injury or possible death.
2. Do not open the power supply unit or handset under any circumstances. The power supply and handset contain no serviceable parts.
3. Do not modify or make any changes to the power supply, handset or other electrical devices.
4. During installation, repair, cleaning, or maintenance work, the power cable must be disconnected from the outlet.
5. The motors control unit is not designed for continuous operation. Changing the desktop position without interruption must not exceed the duty cycle indicated on the power supply. The unit is thermally protected and will temporarily shut down if use exceeds the duty cycle. Allow a 9-minute cooling period for the control unit to reset.
6. The power supply unit may only be operated with voltage as specified on the power supply label.
7. Only use the power cord supplied with the power supply. Check that it is not damaged. Do not operate the power supply unit if the power cord is damaged.
8. Connect the power supply to a proper outlet only. To disconnect turn all controls to the off position, then remove plug from outlet.
9. In the event of a malfunction (e.g. if the control unit keeps adjusting the desk because a movement button has jammed), please unplug the unit immediately.
10. Do not expose the power supply, handset or other electrical device to water or other liquids including moisture, drips, splashes or spills. Only clean electrical device with a dry cloth.
11. Do not operate the power supply, handset or other electrical device in a potentially explosive atmosphere. Do not operate where aerosol spray products are being used or where oxygen is being administered.
12. Do not use the desk if it has been dropped or damaged. Contact the manufacturer for examination or repair.
13. It is not allowed to connect self-constructed products to the power supply, handset or other electrical device. To prevent damage, use only components recommended by the manufacturing company.

WARNING—Risk of injury, or death

1. During the raising or lowering of the table there exists a risk of squeezing or pinching between the moving desktop and fixed objects.
2. The necessary safety margins depend on the greatest type of injury risk that can be predicted. Where possible small pinch points exist (i.e. fingers) use at least a one inch (2,5 cm) safety margin and for body or head (especially where children may be present) use a minimum of 16 inch (41 cm) count from the floor or from their top of the table feet if that is relevant.
3. During the lowering or raising of the desktop, the operator must ensure that no person or object risk being harmed by the operation.
4. This tag (at right) should be located on the table during the initial installation.
5. Keep children away from moving parts and underneath the table.
6. The intended use of the table is adjusting a work surface between sitting and a standing position. The table is not designed for other uses.
7. The table must only be operated while in an upright position and must under no circumstances be operated while upside down.
8. The table must not be overloaded. The maximum allowable load is shown on the power supply label.
9. The table must be operated in a dry, enclosed space, such as an office or similar, Do not operate outdoors.
10. The table is equipped with Collision Detection System (CDS). In the event of a faulty components (i.e. motor or handset) the desktop may move slightly before the safety feature is engaged. Stay clear of pinch points when the desktop is moving.
11. This table is not intended for use by individuals (including children) with limited physical, sensory or mental abilities or with a lack of experience and/ or lack of expertise, unless they are supervised by a person responsible for their safety or have received instructions from that person on how to use the control unit.
12. Children must be supervised at all times to ensure that they do not play with the control unit.
13. The table may not be used to lift people. Do not sit or stand on a table while it is be raised or lowered.
14. The table must not be structurally or technically altered or modified in any way.

1.2 User Information

This column system is rated for commercial use only and is rated for a maximum load of 265 pounds, uniformly distributed (120kg) including the tabletop

The motors may only be used continuously for 1 minute after which the table will automatically shut-off for 9 minutes.

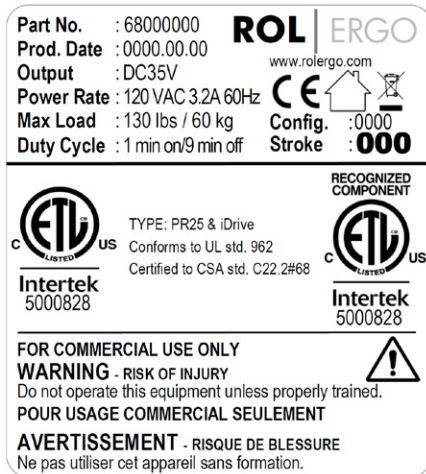

Typical Product Label with Date of Manufacture

1.3 Before you start:

Check for and remove obstacles in path of the table top.

Before first use, the control unit must register the lowest point of elevation. Do the reset as **section 3.2**.

Under normal conditions the system communicates internally and knows the position of each column.

If there are differences in column height, please do a manual reset as listed in **section 3.2**.

1.4 Electrical rating

Electrical rating, input: 120VAC, 50-60Hz, 3,2A.
 Output 35V.

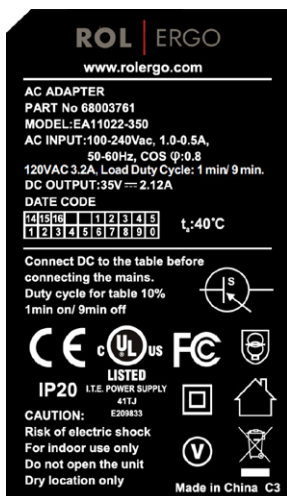

Typical power supply label

2. Assembly & Adjustment

2.1 Assembly Instruction

The official assembly instruction can be found with the base components.

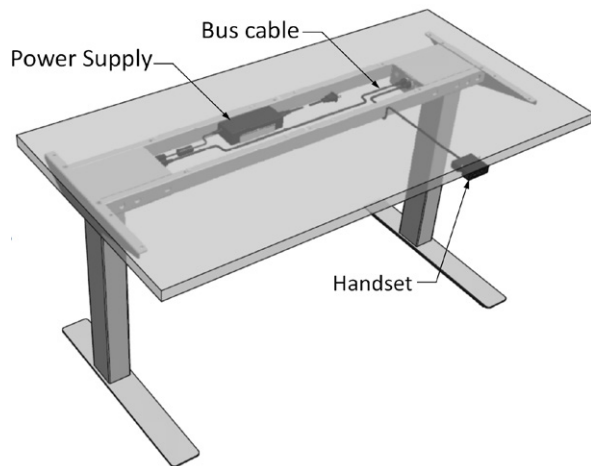

Make sure to ask your desk vendor for an approved combination of desktop and frame.

2.2 Setup procedure

CAUTION—Risk of electrical shock

The main power cord must be unplugged during the setup.

To setup the table:

1. Connect the handset to a 3-pin motor/motor house or to Bus cable socket. **P/N: KR3ae4025/ KR3ae4026**
2. Connect the Bus cable between each motor/motor house. **P/N: KR68002414/ KR68003122/ KR68002583/ KR68002489** (length 31", 47", 63", 78").
3. Connect the power supply to the motor/motor house. **P/N: KR69000121.**
4. Assemble the power cord to the power supply. **P/N: KR68002262.**
5. The table is ready for use, connect the power cord to the outlet.

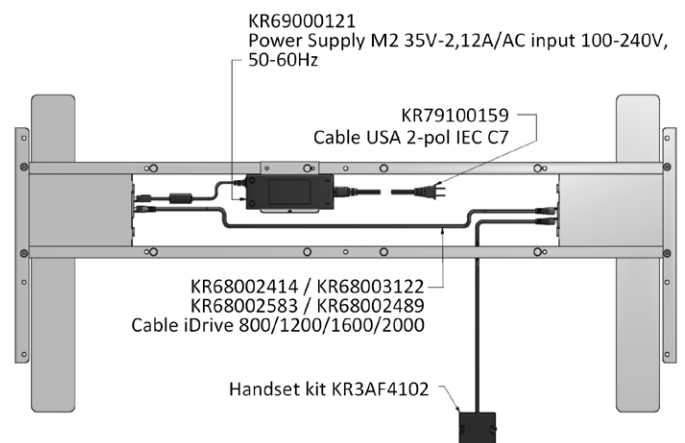

2.3 Optional mounting guidelines

! NOTICE

When disconnecting components such as the power supply, Bus cable or the handset, the strain relieve hook must be pressed before removing the connector. When inserting the connector, an audible “click” indicates that the strain relieve hook has correctly re-engaged.

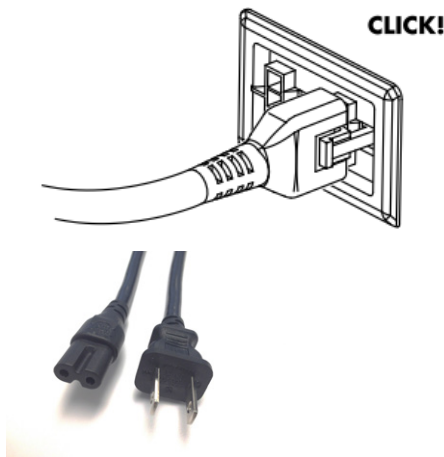

! DANGER—Grounding instruction

This product does NOT require grounding to earth. This product is double insulated and equipped with a polarized 120V plug and 2-conductor cord. The plug must be plugged into an appropriate building outlet that is properly installed in accordance with all local codes and ordinances. Please read **section 4.4** as well.

! DANGER—Risk of electrical shock

Improper connection of the equipment can result in a risk of electric shock. Check with a qualified electrician for any concerns. Do not modify the plug provided with the product – if it will not fit the outlet have a proper outlet installed by a qualified electrician.

This product is designed for the voltage indicated on the power supply label. No adapters should be used with this product.

! CAUTION—Risk of electrical shock

Before you plug in the power cord, check the following again:

- The voltage must be as specified on the power supply label.
- When the power cord is plugged in, the electrical control devices are operational.

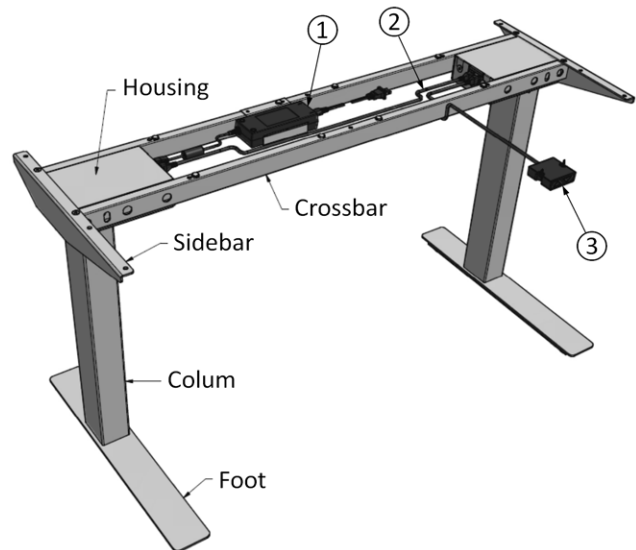

! NOTICE

in case of a power failure or if the power cord is unplugged during the movement of the drives, a manual reset may be necessary! See **section 3.2**

2.4 System configuration (example)

The figure below shows a configuration example consisting of:

- 1 Power Supply
- 2 Bus cable
- 3 Handset

2.5 Adjustments

The table control, handset and motors are sealed units and have no parts that can be serviced or adjusted by the user. In case of failure/unexpected operation or for maintenance please contact your vendor or arrange for service by a qualified technician.

To ensure safe operation of the Tone Electric & Extended Electric unit, please observe the following safety instructions:

CAUTION—Risk of injury and electric shock

Keep children away from electric height-adjustable desks, control units and handset.

CAUTION—Risk of pinching

When you change the desktop position (especially without using pinch protection), you must ensure that no people or objects are located in the hazardous area nor may reach into it.

NOTICE

In case of a main power breakdown, or if the power cord is unplugged during the movement of the drives, a manual reset may be necessary! Please see **section 3.2**.

NOTICE

The control unit might be damaged by power surges. Unplug the power cord during a thunderstorm or if you do not intend to use the desk for a longer period.

3 Operation Instructions

3.1 Basic functions

NOTICE

You must read the user manual carefully before installing or operating the control unit.

If chosen handset doesn't fit to this user manual, please see separate user manual for actual handset.

3.1.1 Upward desktop movement

This function enables the upward adjustment of the work surface. To change its position, proceed as follows:

 Press the desktop up button and continue to hold until desired desktop height is reached.

NOTICE

The desktop will continue moving upwards until you release the button or the maximum height is reached

3.1.2 Downward desktop movement



This function enables the downward adjustment of the work surface. To change its position, proceed as follows:

 Press the desktop down button and continue to hold until desired desktop height is reached.

3.2 Advanced functions, Manual reset/homing

If a motor (or electronic) has been disconnected from the column, during or after the assembly, a reset (homing) cycle MUST be performed. A reset (homing) cycle

should be made with an even weight of approx.. 100 lbs. (45 kg) applied on the table.

-   1. Simultaneously pressing the **up** and **down** buttons for minimum of 8 seconds.
-  2. Press and hold the **down** button and the table will slowly move the lowest point possible.
3. The table/stand is ready for normally use.

3.3 CDS (Collision Detecting System)

This table is equipped with a Collision Detection feature designed to avoid possible severe injury due to pinching. When the table detects a sudden change in resistance (force) equal to approximately 120 lb (55kg) the CDS will stop the movement of the table and reverse approximately 1 inch (25mm). CDS works in both directions, i.e. upwards and downwards. Remove the obstacle prior to operating the table again. The CDS will be active again as soon as the table has been moved (up or down) 3,15 inch (80mm).

CAUTION—Risk of pinching

The Collision Detection System (CDS) is a last resort safety feature and is not designed to detect and prevent all possible pinching and injuries. The effectiveness of the CDS is effected by the speed of the table, the location of the table top and the density of obstruction. Even in the event that the CDS is activated it may not completely prevent injury and all possible safety measures should be taken in order to prevent possible injury.

CAUTION—Risk of pinching

The Collision Detection System (CDS) is not enabled during all resets and limit position calibration.

4 Maintenance & Repairs

4.1 Cleaning, Inspection and Storage

Clean the table frame by wiping it down with a microfiber cloth. Never use solvent or abrasive or corrosive compounds.

Products must be cleaned at regular intervals to remove dust and dirt and inspected for mechanical damage and normal wear and tear. Worn-out parts must be replaced.

Unplug the power cord if you do not intend to use the desk for a long period.

Do not store table or cables in direct sunlight

4.2 User Maintenance

Products are closed units and require no internal maintenance.

Columns must be inspected at attachment points, wires, cabinet, and plugs, check that columns function correctly.

- Inspect the column for loose connections and damaged plugs/wires.
- Inspect power supply for loose connections and damaged plugs/wires.
- The power supply and the handset is sealed and maintenance free.

4.3 Repairs

Check all screws and bolts after the first week of use and tighten screws and bolts where necessary to ensure safe operation of the table.

If the table cannot be raised or lowered, check the cable connection between:

- the power supply and the motor/motor house (column system).
- the handset and the motor/motor house.
- the columns/motors.
- If the table still does not operate, the control system may have triggered the overheating or duty cycle protection. Please wait for at least 9 minutes and try again before proceeding.

If a control unit is replaced, a manual reset (homing) is required. Follow these steps as **section 3.2**.

If the table is still not operational, please contact your vendor for further assistance.

The control system is equipped with safety features; the intermittency function and the overheating protection and memory function.

Duty cycle function – The duty cycle factor of the table 1:9 meaning 1 minute of operation must be followed by 9 minutes of inactivity. If this limitation is exceeded, the table will become inoperable until the control box resets automatically.

Overheating protection – The table will become inoperable if the overheating protection is triggered and will return to operation automatically once the heat has dissipated sufficiently.

Memory function – The control system (each column) will retain information regarding the elevation of the table at all times. This information will remain stored even in case of power failure or if the power cable is disconnected from the power outlet.

Soft start – Progressive acceleration allows for soft starts and stops.

Speed – the speed of the table varies with load.

4.4 Servicing of double-insulated products

In a double-insulated product, two systems of insulation are provided instead of grounding. No grounding means is provided on a double-insulated product, nor is a means for grounding to be added to the product.

Servicing a double-insulated product requires extreme care and knowledge of the system, and is to be done only by qualified service personnel. Replacement parts for a double-insulated product must be identical to the parts they replace. A double insulated product is marked with the words "DOUBLE INSULATION" or "DOUBLE INSULATED". The symbol (square within a square) is also able to be marked on the product.

5 Appendix

5.1 Dimensions column system: Tone Extended Electric with 665 stroke

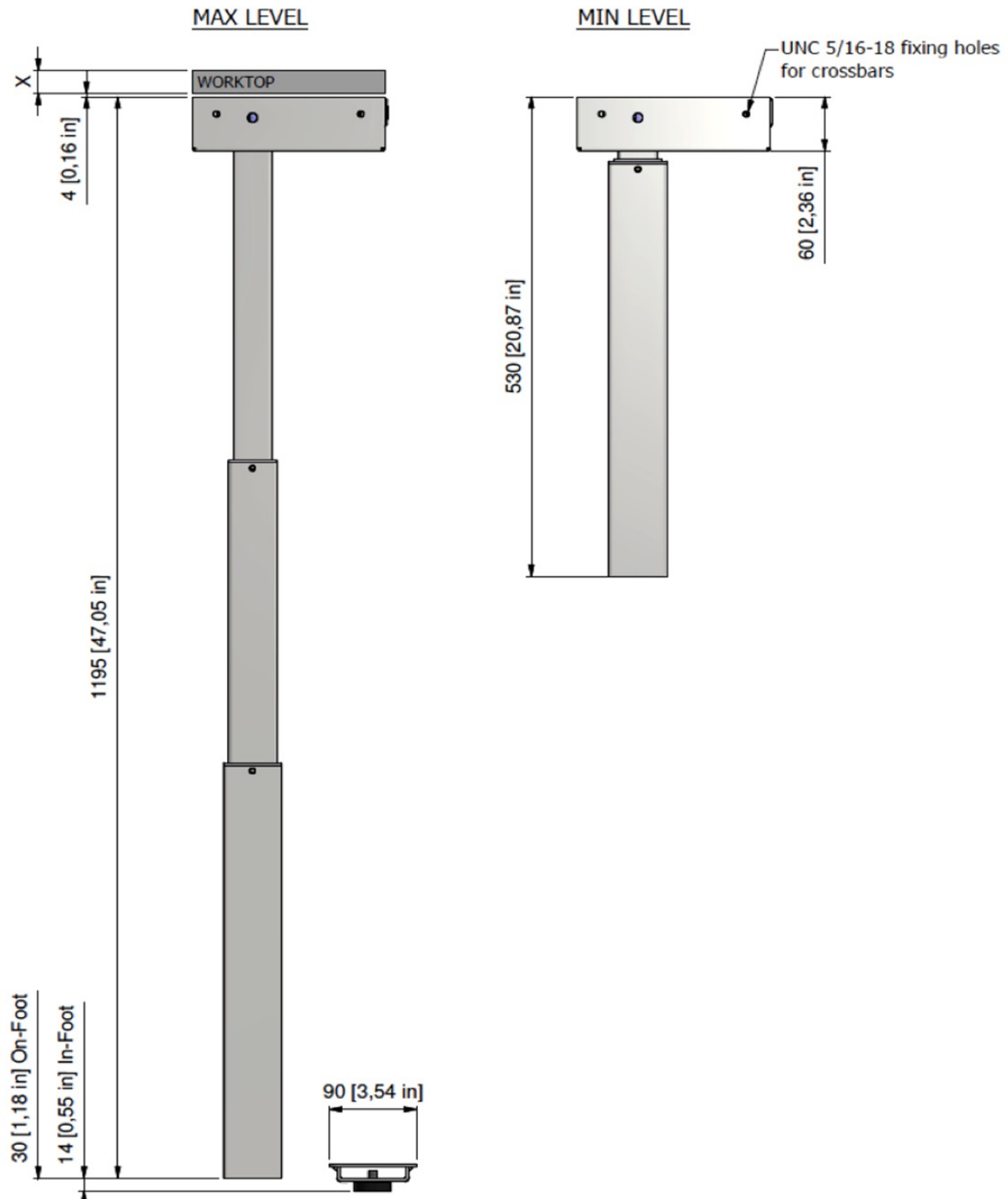

5.2 Dimensions column system: Tone Electric with 420 stroke

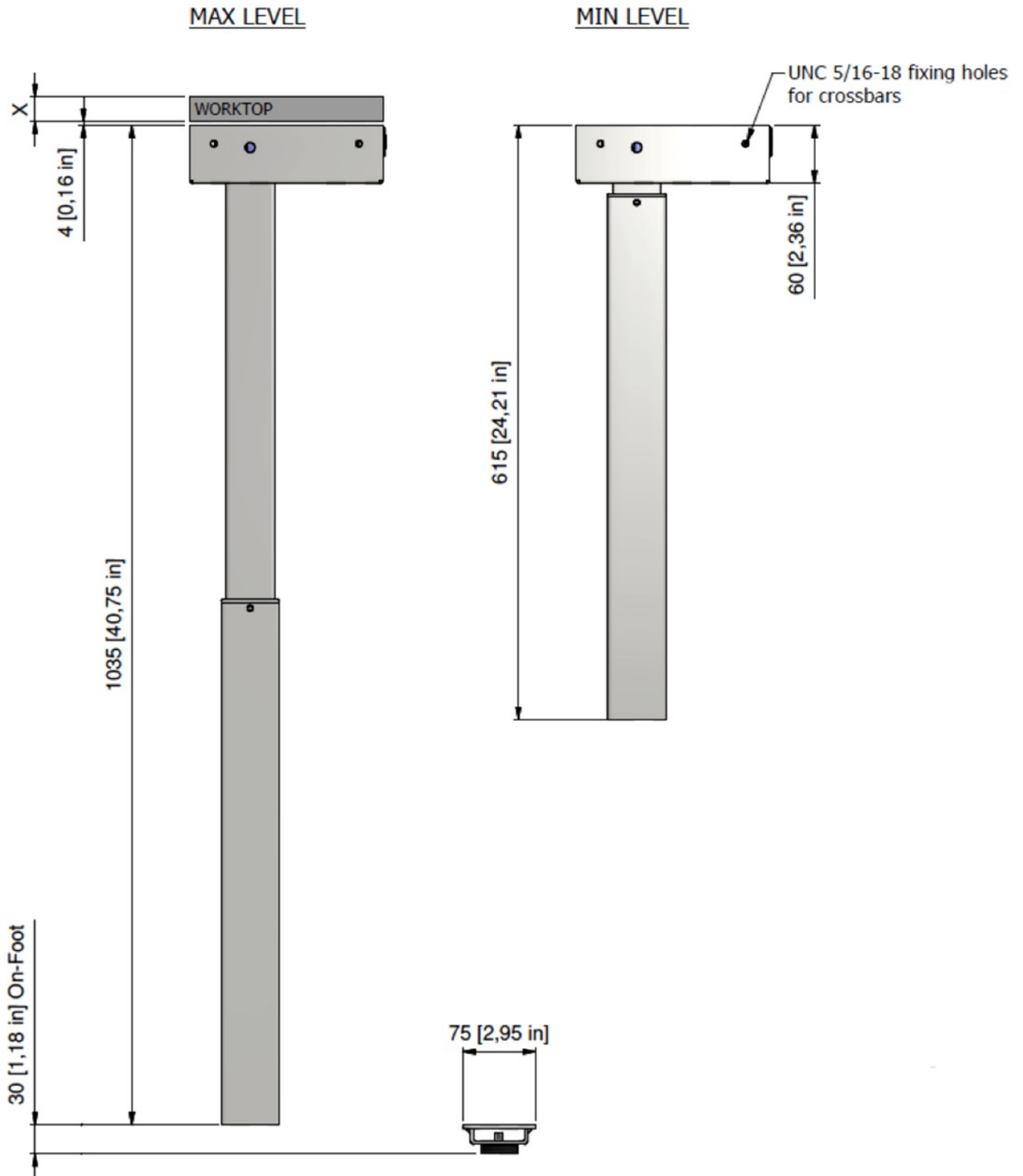

5.3 Accessories

Tone Electric & Extended Electric

Standard Handset: **P/N KR3AF4102**



Digital Handset: **P/N KR3AF4103**



Power supply: **P/N KR69000121**

Cable: **P/N KR79100159**; Length 9"



Bus cables:

Length 31-1/2", **P/N KR68002414**

Length 47", **P/N KR68003122**

Length 63", **P/N KR68002583**

Length 78", **P/N KR68002489**

Bus splitter, **P/N KR68003690**

