

Folk 32" Ladder Shelving

Designed by Norm Architects

Customer Service:
1.800.944.2233 inside the U.S.
1.203.614.0600 outside the U.S.



Folk 32" Ladder Shelving

Designed by Norm Architects

Hardware Checklist

4mm Allen wrench

x 1

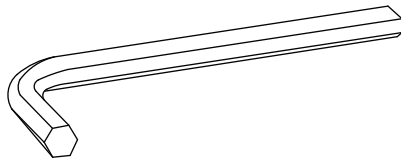

50mm bolt

x 15

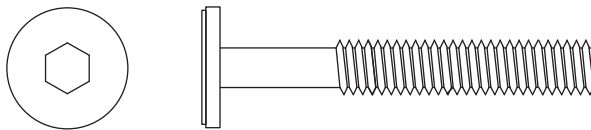

L-bracket

x 2

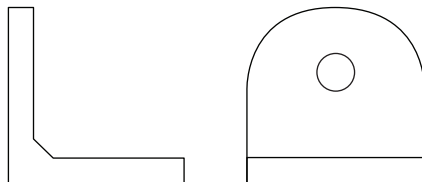

Screw

x 4

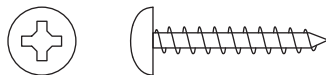

Wall anchor

x 2



Folk 32" Ladder Shelving

Designed by Norm Architects

1. Attach Shelf 1 as shown using 50mm bolts and Allen wrench.
Repeat with remaining shelves.

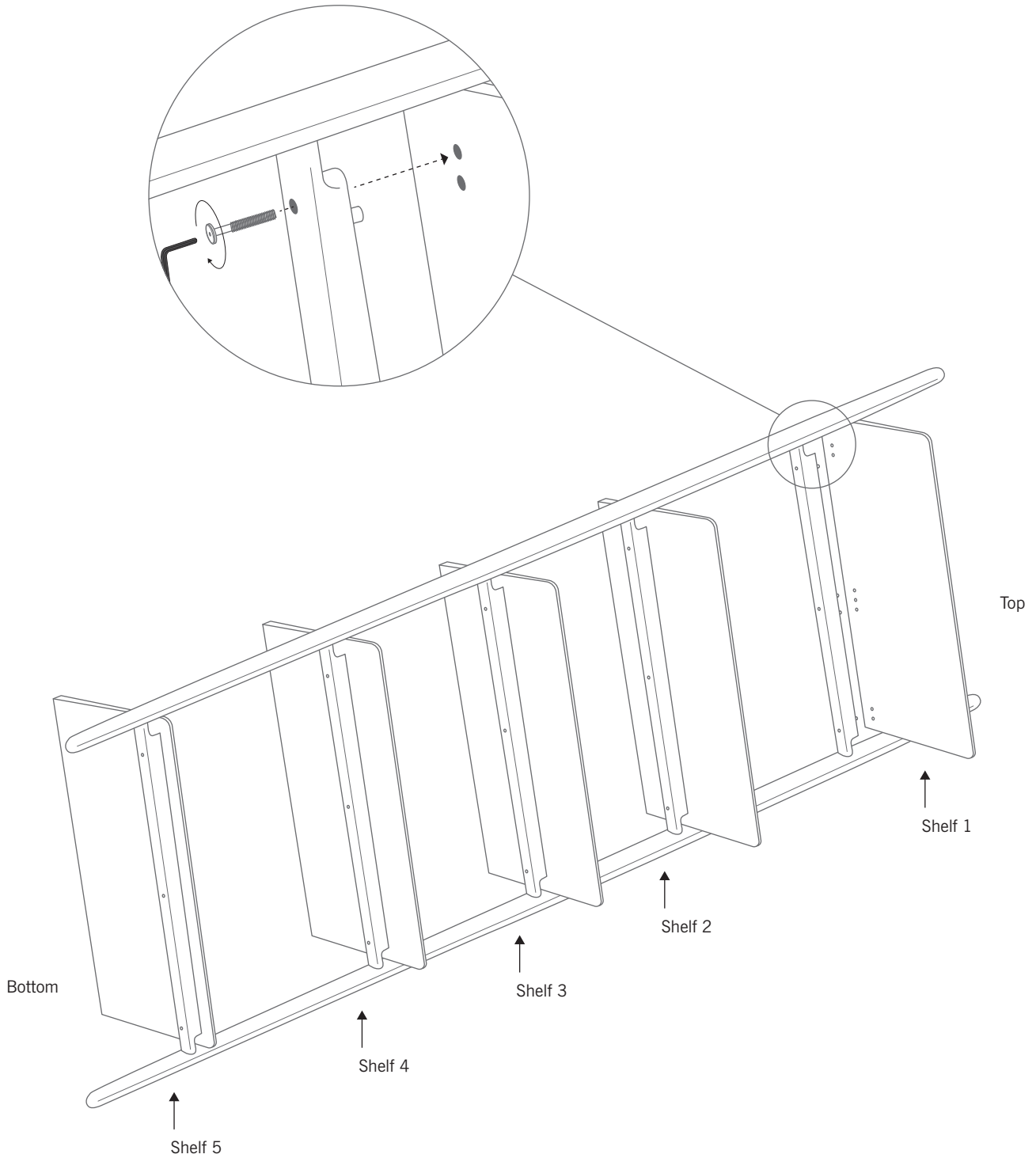

Folk 32" Ladder Shelving

Designed by Norm Architects

2. Ladder shelving must be attached to wall for safety. Attach L-brackets to shelves 3 and 5 as shown. Provided anchors are for drywall use only. Please make sure you are using an appropriate system for your wall type.

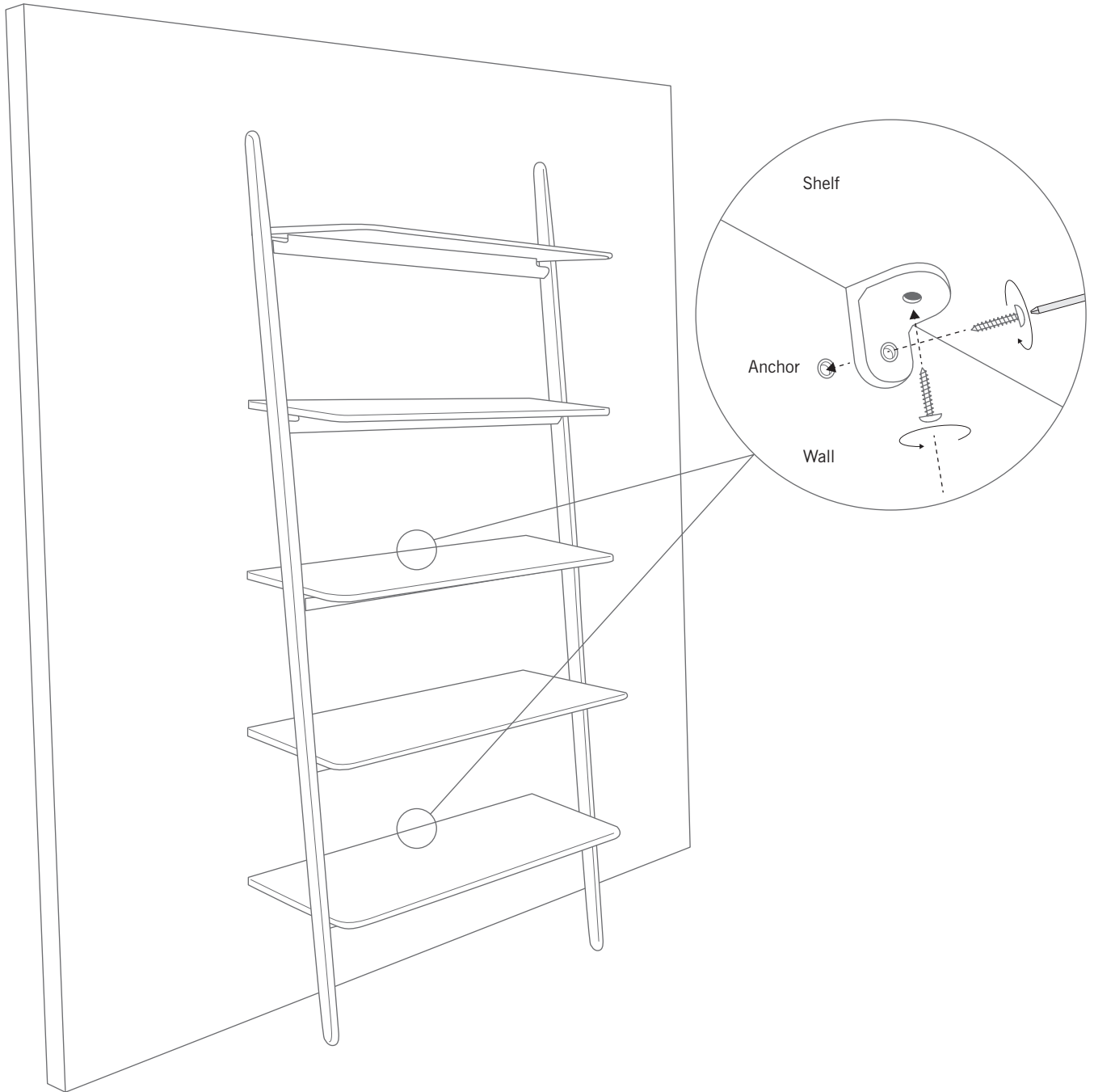

Folk 32" Ladder Shelving
Designed by Norm Architects

